

USA vs. ARG 1/2

1:	
2:	
3:	
4:	
5:	

GS: 1: Anderson, 2: Russell, 3: Sander, 4: Lee, 11: Christenson
17: Holt

G3 starts @ ARG serving 3-1 @ USA p1; USA 9 m for 1 for a few plays

h 3b	10-7
blac	11-7
se	11-8
5 1 +	20-14
ace	1-0
se	1-1
0-1	
9-7	
ace	20-17
se	20-15

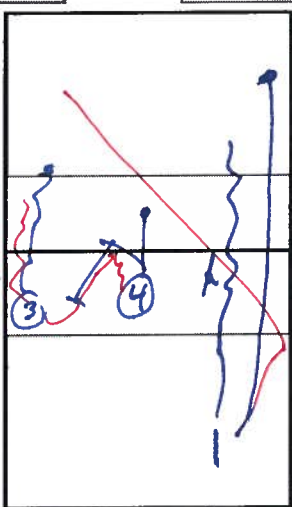

1:	1, 5, 18, 16, 19
2:	10, 10, 20, 23
3:	11, 1
4:	8, 8, 18, 12
5:	

h 3b	10-7
blac	11-7
se	11-8
5 1 +	20-14
ace	1-0
se	1-1
0-1	
9-7	
ace	20-17
se	20-15

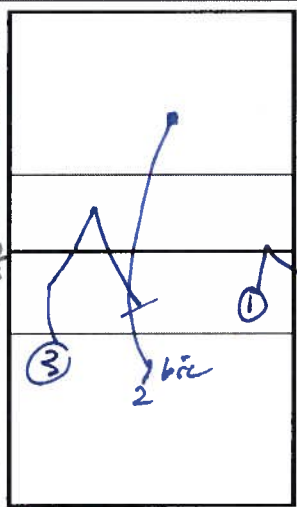

1:	1, 10, 11, 8, 20, 17
2:	1, 1, 12, 11, 21
3:	17
4:	7, 7, 20, 13
5:	

h 1 + 3	
h 1b	2-3
ace	25-81
ace	2-3
se	11-19
h 2 +	2-1
h 20	2-2
ace	20-8
se	21-14

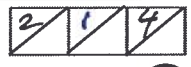
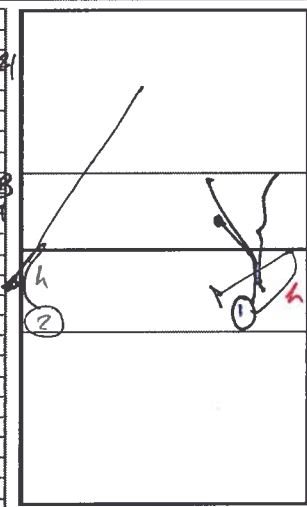

1:	2, 3, 9, 20
2:	3, 13, 25, ace
3:	3, 9, 19
4:	2, 2, 8, 14
5:	

15: Delecco 3

Replays

h 3b	10-7
blac	11-7
se	11-8
5 1 +	20-14
ace	1-0
se	1-1
0-1	
9-7	
ace	20-17
se	20-15

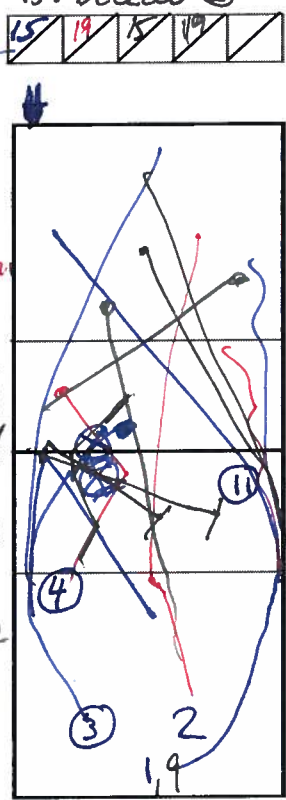

1:	7, 9
2:	11, 21
3:	12, 13, 14, 15, 16, 10
4:	
5:	

USA P6

h 3b	10-7
blac	11-7
se	11-8
5 1 +	20-14
ace	1-0
se	1-1
0-1	
9-7	
ace	20-17
se	20-15

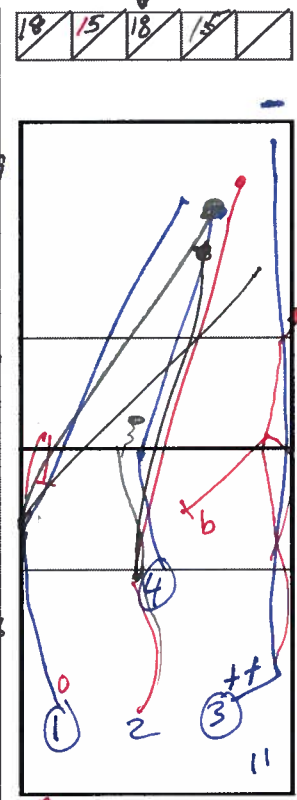

1:	2, 12, 18, 19, 21
2:	2, 12, 13, 24
3:	2, 10, 11
4:	1, 10, 21
5:	

USA P1

h 1 + 3	
h 1b	2-3
ace	25-81
ace	2-3
se	11-19
h 2 +	2-1
h 20	2-2
ace	20-8
se	21-14

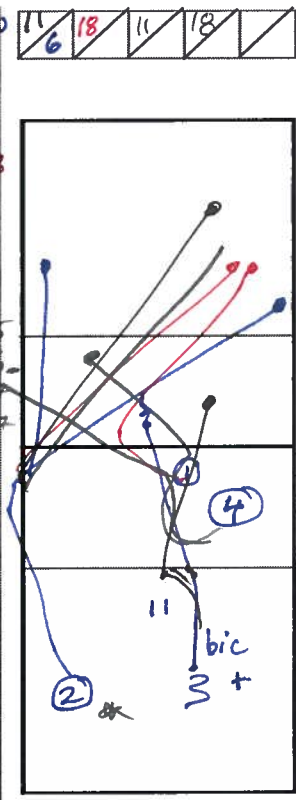

1:	13, 22
2:	3, 14, 0
3:	4, 12, 3
4:	11, 15, 16, 17, 22
5:	

USA P2

USA vs. ARG 2/2

1:	25-20
2:	25-21
3:	17-25
4:	25-20
5:	

a 2+	14
25-0	
1 170	
2 27	23-20
op 17+	24-20
16/k	25-0
7 3 b	3-4
7 1 f+	5-6
	13-14
	13-20
	4-2
	4-3
BLK	12-3
	13-8
	13-9
	22-16
h 2 0	
dig +	23-18

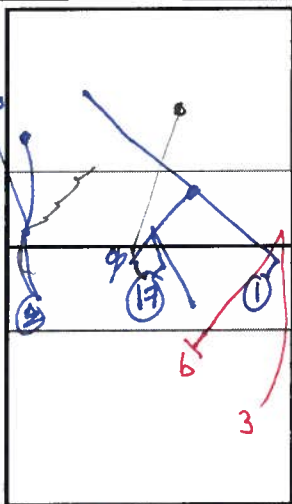

- 1: 3, 10, 14, 23, 24, 25
- 2: 4, 14
- 3: 5, 5, 13, 20
- 4: 4, 3, 12, 13, 9, 18, 23
- 5:

acc	5
acc	6
acc	14-11
14 5 (6)	4-4
blk	6-4
acc	7-4
acc	0
acc	16-14
acc	17-14
op 11+	18-14
1 blk	6-6
acc	7-6
blk	15-21
acc	16-21
acc	16-22
acc	5-4
acc	14-10
acc	24-18
acc	24-19

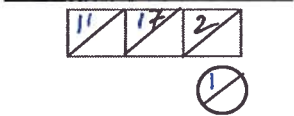
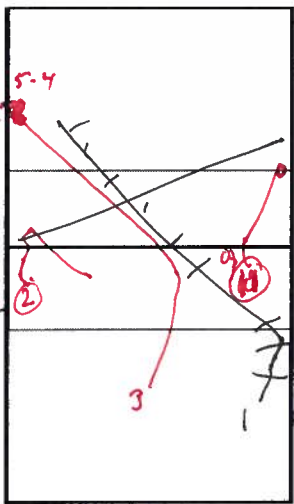

- 1: 5, 6, 4, 12
- 2: 5, 6, 7, 5, 6, 16, 17, 18, 15
- 3: 6, 7, 7, 15, 16, 22
- 4: 4, 10, 24
- 5:

bic 2	+
acc	20-13
acc	21-13
acc	0 8-9
acc	0 8-9
acc	0 8-9
acc	13-25
acc	6-5
acc	18-10
acc	16-17

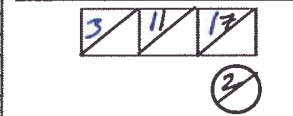
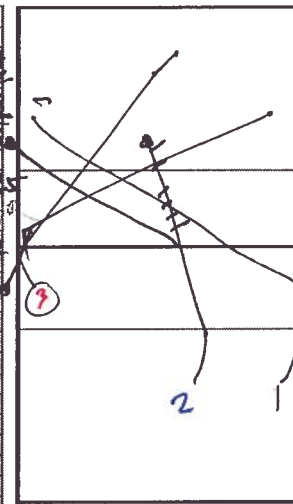

- 1: 5, 16
- 2: 8, 20, 21, 18
- 3: 8, 10, 25
- 4: 5, 16, 12
- 5:

22:00

1 10 R (bic) +
+ 31 9 5 (bic) -
1 9 (0) 0
+ 31 4 (5) +
+ 0 4 5 bic 15-14
op 7-4-6
+ 31 9 4 r 0
acc 13-20
acc 14-21
- 1 2+ 5-3
0 4 5 + 14-9
0 4 5 0

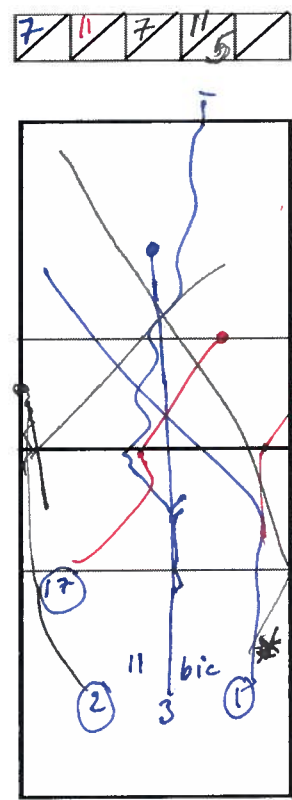

- 1: 11
- 2: 4, 15
- 3: 6, 21
- 4: 5, 14
- 5:

USA p3

0 31 (0) +
+ 31 9 0 0
+ 71 (9) f
op 7-6
- 2 2 0 7-7
0 4 D + 8-7
- 2 2 0 18-16
0 4 D - 18-17
acc 19-17
+ 1 9 D bic 8-7
h 0 16-23
0 3 1 D 16-24
0 3 1 D + 17-21
acc 8-4
acc 15-10
acc 24-20
+ 0 9 D + 25-22

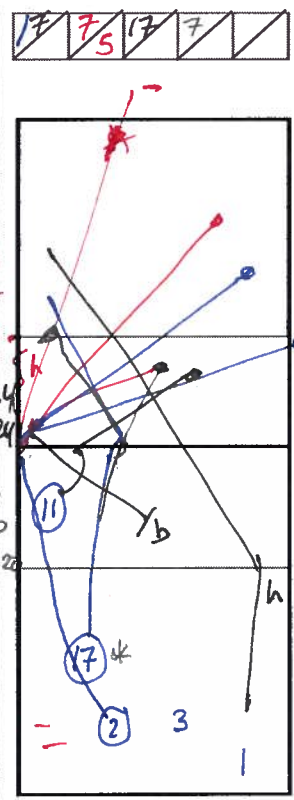

- 1: 7, 13, 15
- 2: 7, 8, 16, 17, 19
- 3: 8, 23, 24, 17
- 4: 6, 15, 20, 25
- 5:

USA p4

+ 6 1 9 D +
+ 31 9 0 +
+ 31 9 0 +
1 9 0 - 8-9
+ 0 9 D + 9-9
+ 0 9 bic 22-19
- 0 7 8-9
+ 31 5 0 0
+ 0 5 0 4-10
+ 31 9 0
+ 1 9 0 + 7-5
- 2 3 0 + 17-11

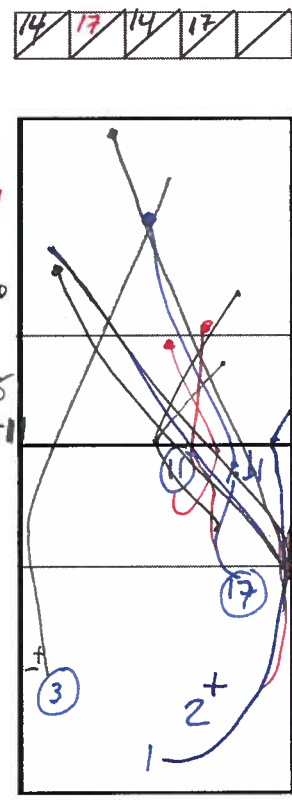

- 1: 8, 15, 17
- 2: 9, 9, 22
- 3: 9, 9
- 4: 7, 17
- 5:

USA p5